

Bone Expander System

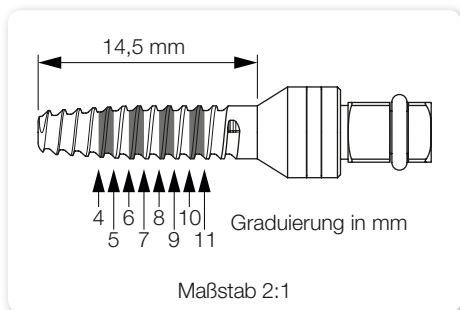











Bone Expander System

Um horizontal resorbierten Knochen kontrolliert minimal-invasiv zu weiten, kann dies mit schraubenförmigen Spreadern alternativ zu Osteotomen durchgeführt werden.

Dabei wird spongiöser Knochen verdichtet und die Primärstabilität des Implantats bei der anschließenden Implantation erhöht.

Inhalt: Bone Expander System

Abbildung	Artikelbeschreibung	Bestellmenge
	47.565.00 Bone Expander System im Waschkorb 1/3 mit Deckel (REF 85.192.65) bestehend aus:	1 Set
	47.565.05 Expansionsschraube 1,8 x 2,5 mm x 14,5 mm	1 Stück
	47.565.06 Expansionsschraube 2,0 x 3,0 mm x 14,5 mm	1 Stück
	47.565.07 Expansionsschraube 2,5 x 3,5 mm x 14,5 mm	1 Stück
	47.565.08 Expansionsschraube 2,8 x 4,0 mm x 14,5 mm	1 Stück
	47.565.09 Expansionsschraube 3,0 x 4,5 mm x 14,5 mm	1 Stück
	47.800.05 Ratsche ohne Drehmoment	1 Stück
	47.565.01 Adapter mit Dentalanschluss	1 Stück
	47.565.02 Adapter mit Vierkant-Anschluss	1 Stück
	47.099.08 Trennscheibe Ø 8 mm	1 Stück
	08.525.16 Bohrer Ø 1,96 x 15 mm	1 Stück



AESTHETIC IS THE RESULT